

# NARDI

IMPLEMENTS  
FOR PROFESSIONAL  
FARMING



## NX 23-33

HP 80 -150



Aratri reversibili con spostamento a parallelogramma per lavori entro solco



Reversible ploughs with parallelogram for in-furrow ploughing



# NARDI

IMPLEMENTS  
FOR PROFESSIONAL  
FARMING

 Aratri reversibili a parallelogramma per lavori entro solco con testa oscillante, larghezza di lavoro variabile idraulicamente e bullone di sicurezza

**A RICHIESTA:** martinetto di ribaltamento con memoria, avanvomeri, deflettori, soprali, coltro dal basso, ruote di profondità e trasporto.

Varie tipologie di corpi: cilindrici, elicoidali, a scalpello, a strisce e con polietilene

 Reversible ploughs for in furrow, out-of-furrow and border ploughing with hydraulic displacement of working width. Shear bolt safety system.

**OPTIONAL:** hydraulic tipping cylinder with memory, baffle, top wing, bottom coulter, skimmers-depth control and transport wheels.

Available working bodies: cylindrical, universal, strips, chisel, and bodies with polyethylene

## Di Serie - Standard

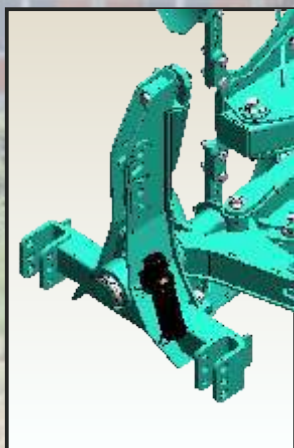

Testata Fissa con attacco di II e III N. Cat.  
Fixed Headstock with II and III Cat. hitch

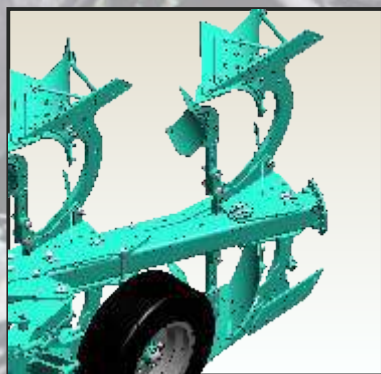

Comando della variazione idraulica della larghezza di lavoro posizionato a destra (senza ingombro in finitura)  
Hydraulic displacement control set on the right side

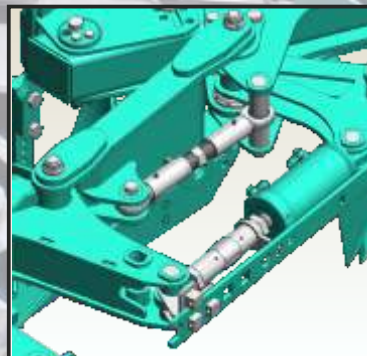

Bure spostamento del tipo scatolato chiuso e sequenza per autoallineamento al ribaltamento (di serie su 4 - 5 corpi)  
Box type displacement beam and sequence for selfalignment on turnover (standard on 4-5 furrows)

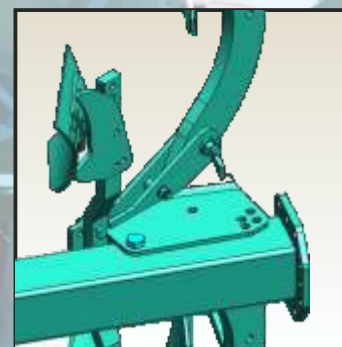

Bullone di sicurezza  
Shear bolt

## Accessori - Optionals



Ruota centrale di profondità e trasporto  
Central depth and transport wheel

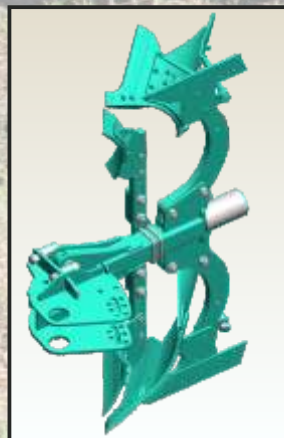









Sistema idraulico NON STOP  
NON STOP hydraulic system



Ruota posteriore reversibile in gomma  
Rear rubber reversible wheel











Portattrezzi con barra oscillante e blocco meccanico per il trasporto con attacco di II, III N e III Cat.  
Oscillating headstock with mechanical locking for transport purpose

Mod. NX23										
	N°		mm	Hp	Kw	cm	cm	cm	cm	Kg
<b>TRIVOMERI VARIAZIONE DELLA FETTA IDRAULICA - 3 FURROWS HYDRAULIC ADJUSTMENT</b>										
NX23TO/3	3	EL6R/A	140 + Ri. lat.	100-120	74-88	105	96-201	25-35	82	1.300
NX23TO/3	3	CN7T	140 + Ri. lat.	120-140	88-103	105	96-201	33-40	82	1.400
<b>QUADRIVOMERI VARIAZIONE DELLA FETTA IDRAULICA - 4 FURROWS HYDRAULIC ADJUSTMENT</b>										
NX23XTO/4T	4 (3+1)	CN6T	140 + Ri. lat.	140-180	103-132	105	128-270	30-35	82	1.600
NX23XTO/4T	4 (3+1)	EL6R/A	140 + Ri. lat.	130-150	95-110	105	128-270	25-35	82	1.520

**CORPI A RICHIESTA NX23 - OPTIONAL BODIES**

	EL5	EL5R	EL6R	CL6R	CN6	CN7	ESN7	ELS6R	CN6P	CN7P	SC5.5	SC7
Trivomeri - 3 Furrows	•	•	•	•	•	•	•	•	•	•	•	•
Quadrivomeri - 4 Furrows	•	•	•	•	•	•	•	•	•	/	•	/

Mod. NX33										
	N°		mm	Hp	Kw	cm	cm	cm	cm	Kg
<b>TRIVOMERI (VARIAZIONE DELLA FETTA IDRAULICA - 3 FURROWS HYDRAULIC ADJUSTMENT)</b>										
NX33XTO/3L	3	CN8T	140 + Ri. lat.	180-240	132-176	120	114-189	38-45	90	1.800
<b>QUADRIVOMERI (VARIAZIONE DELLA FETTA IDRAULICA)</b>										
NX33XTO/4TL	4 (3+1)	CN7T	140 + Ri. lat.	180-240	132-176	120	152-254	33-40	90	1.850

**CORPI A RICHIESTA NX23 - OPTIONAL BODIES**

	EL5	EL5R	EL6R	CL6R	CN6	CN7	CN8	ESN7	ELS6R	CN6P	CN7P	CN8P	SC5.5	SC7	SC10/9
Trivomeri - 3 Furrows	/	/	/	/	•	•	•	•	/	•	•	•	/	•	•
Quadrivomeri / 4 Furrows	/	/	/	/	•	•	/	•	/	•	•	/	/	•	/



# NARDI

IMPLEMENTS  
FOR PROFESSIONAL  
FARMING

## I corpi disponibili Working bottoms

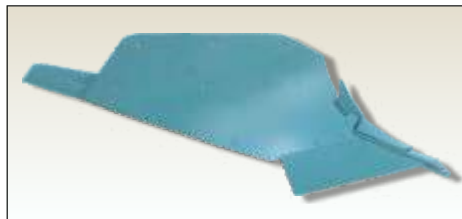

Corpo a scalpello per terreni leggeri e medio pesanti, con presenza di pietre  
Chisel body medium heavy soils with stones

mod. prof.cm.

**SC5.5** 27-32

**SC7** 30-35

**SC10/9** 36-42



Corpo normale con versoio cilindrico con scalpello sovrapposto, adatto per tutti i tipi di terreni leggeri e medio pesanti, anche umidi.  
Scalpello con riporti di carburi di tungsteno  
Standard bottom with cylindrical mouldboard and overlying chisel suitable for all kinds of light and medium-heavy soils including wet soils. Chisel with carryovers of tungsten carbide

mod. prof.cm.

**CL6R** 25-35

**CN6** 30-35

**CN7** 33-40

**CN8** 38-45



Corpo con versoio elicoidale con scalpello sovrapposto, adatto per terreni umidi, medio-pesanti, anche colloidali. Scalpello con riporti di carburi di tungsteno  
Helicoidal bottom with overlying chisel suitable for wet soils, medium-heavy or colloidal soils. Chisel with carryovers of tungsten carbide

mod. prof.cm.

**EL5** 20-30

**EL5R/A** 20-30

**EL6R/A** 30-35



Corpo con versoio a striscie con scalpello sovrapposto, adatto per terreni umidi, medio pesanti, anche colloidali. Scalpello con riporti di carburi di tungsteno  
Band type bottom with overlying chisel suitable for wet soils, medium-heavy or colloidal soils. Chisel with carryovers of tungsten carbide

mod. prof.cm.

**ELS6R/A** 30-35

**ESN7** 33-40

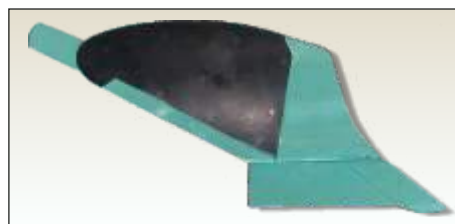

Corpo normale con versoio in polietilene con scalpello sovrapposto, anche per terreni collosi. Scalpello con riporti di carburi di tungsteno  
Standard bottom with mouldboard in polyethylene and overlying chisel, also for colloidal soils. Chisel with carryovers of tungsten carbide

mod. prof.cm.

**CN6P** 30-35

**CN7P** 33-40

**CN8P** 38-45

## Accessori-Accessories

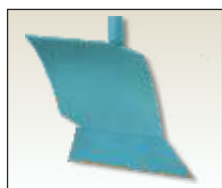

Avanvomere cilindrico  
Cylindrical skimmer



Avanvomere normale  
Standard skimmer



Avanvomere da mais  
Corn skimmer

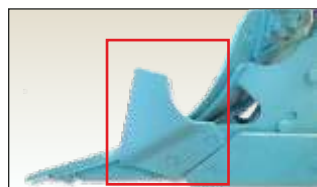

Coltro dal basso  
Bottom coulters

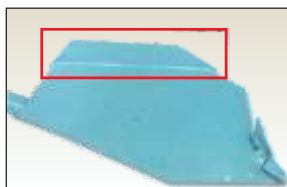

Soprala  
Top wing



Deflettore  
Baffle

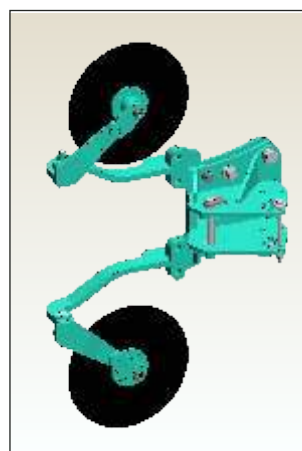

Coltro a disco  
Disc coulters

I dati di peso e di lavoro contenuti nella presente illustrazione s'intendono forniti a semplice titolo indicativo e non impegnativo.

The weight and working data contained in the present leaflet are supplied for information only and are not binding

ASSOCIATI:



**NARDI** S.p.A

Via del Lavoro 24/26  
06016 Selci Lama (PG) Italy  
tel. +39 075 8610611  
fax +39 075 8583446  
e-mail: info@grupponardi.it  
www.grupponardi.it